

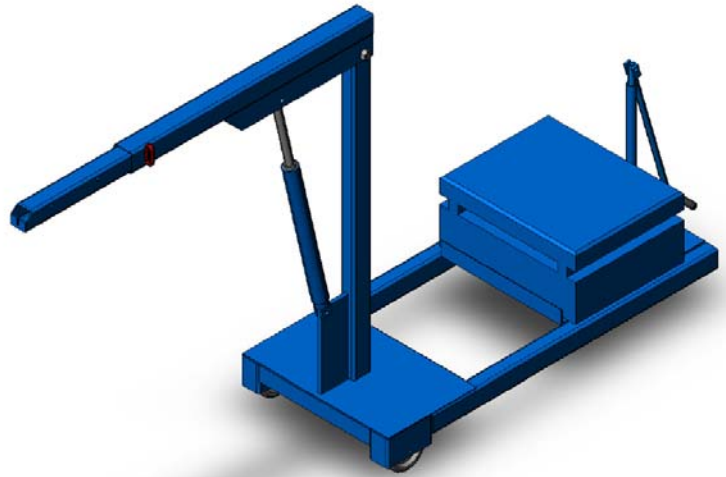

David Round & Son, Inc.
Ruger Division
10200 Wellman Rd
Streetsboro, OH 44241
Phone: 330-656-1600
Fax: 330-656-1601
info@davidround.com
www.rugerindustries.com

Ruger® HP2000R



HP2000R

- 2000 lb. Capacity
- Reversed based allows for easier access to loads

OPTIONAL ACCESSORIES

- Floor Lock - Direct Bolt-On
- Polyurethane Wheels - Direct Bolt-On
- Phenolic Wheels - Direct Bolt-On
- Power-Pak - Direct Bolt-On AC/DC Operated Hydraulic Lifting
- Swivel Boom - Limited Swing Motion Design
- Manual Hand Winch - Rated for Lifting Design
- Power Assist - Direct Bolt-On DC Operated Drive Unit Attachment
- Available in Stainless Steel Construction

Meets ASME PALD standards
for shop cranes.
Conforms to ANSI Z535 standards.

Standard Features

- Meets Ruger's structural engineering standards for 125% of rated lifting capacity
- Counterbalanced units are built to exceed 125% stability factor
- Double action manual hand pump operation
- Built-in hydraulic overload relief valve
- Needle type release valve permits pin-point control over lowering and holding of the heaviest or lightest loads
- Adjustable built-in telescopic boom
- Steel wheels with sleeve bearings
- Swivel hook with safety latch
- Steel construction & standard Ruger blue paint

Prices, specifications, and options are subject to change without notice. All Ruger products are shipped F.O.B. Streetsboro, OH 44241



David Round & Son, Inc.
 Ruger Division
 10200 Wellman Rd
 Streetsboro, OH 44241
 Phone: 330-656-1600
 Fax: 330-656-1601
 info@davidround.com
 www.rugerindustries.com

MODEL: HP2000R

Load Capacity 2000 lbs

Figure 1

